

Opgave 3

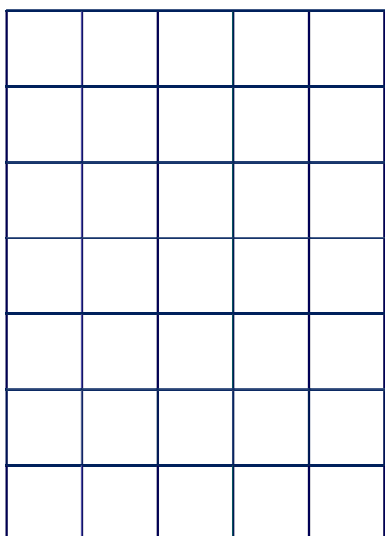

Opgave 4

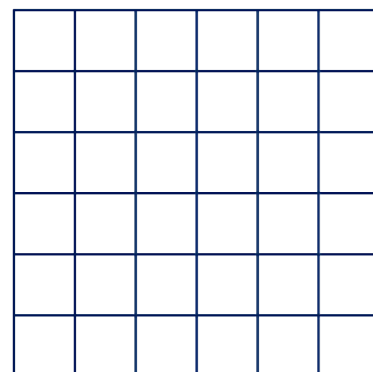
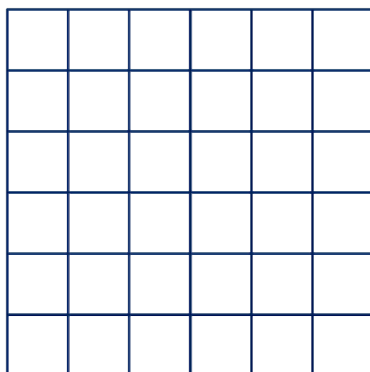
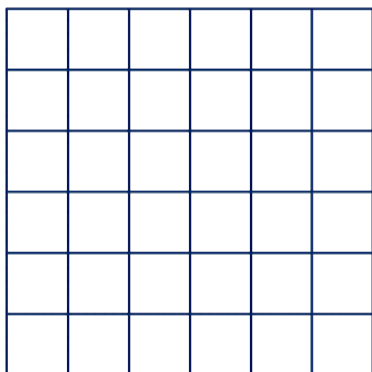

Opgave 10

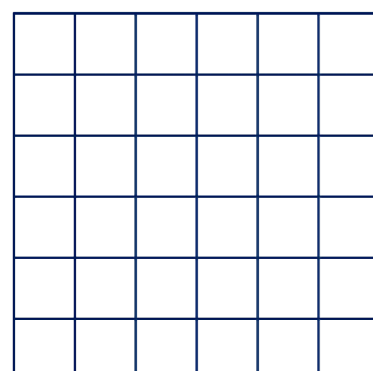
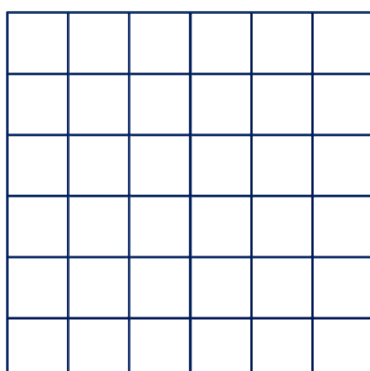
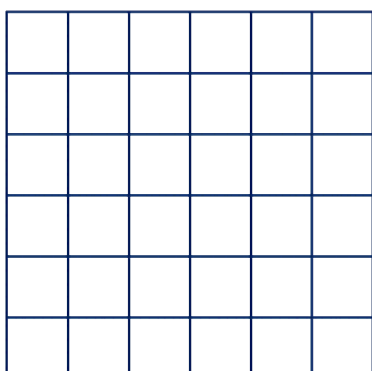

Opgave 12

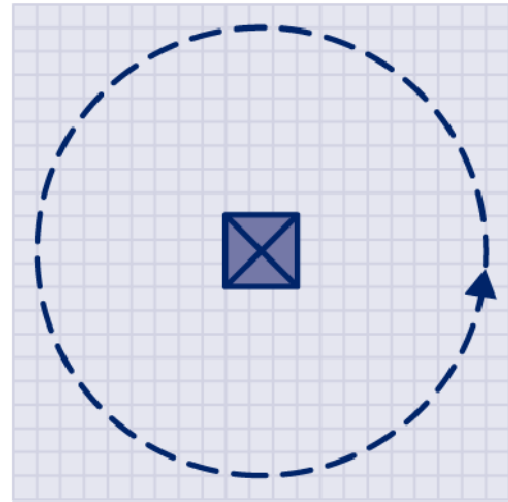
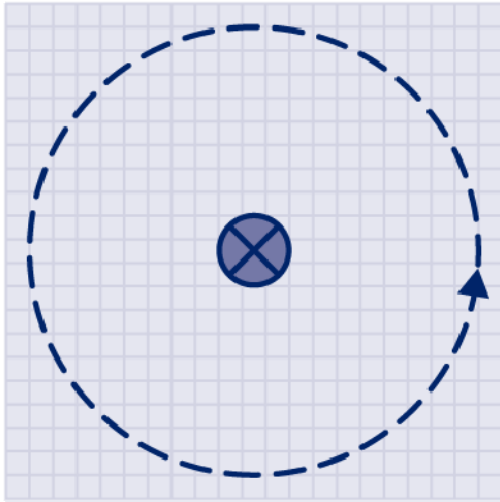

Opgave 15

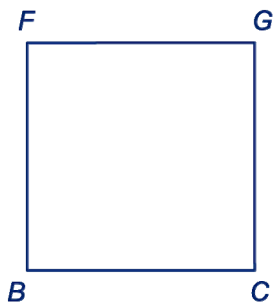

kijkrichting BA

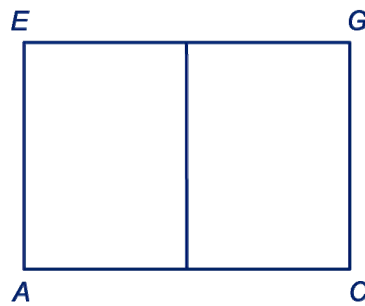

kijkrichting BD

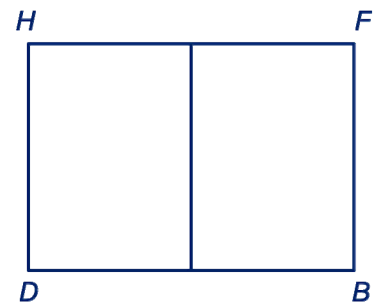

kijkrichting AC

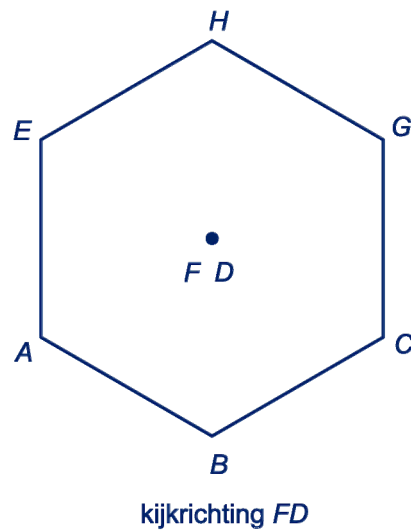

kijkrichting FD

Opgave 27

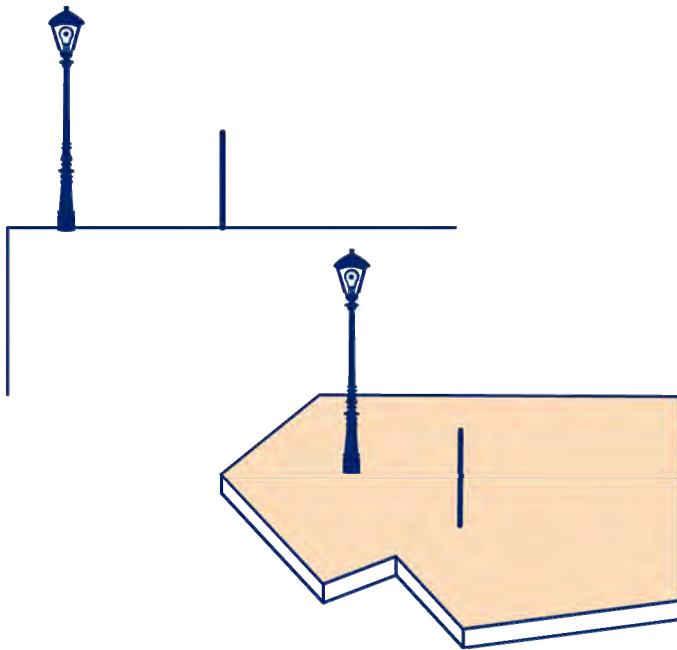

Opgave 28

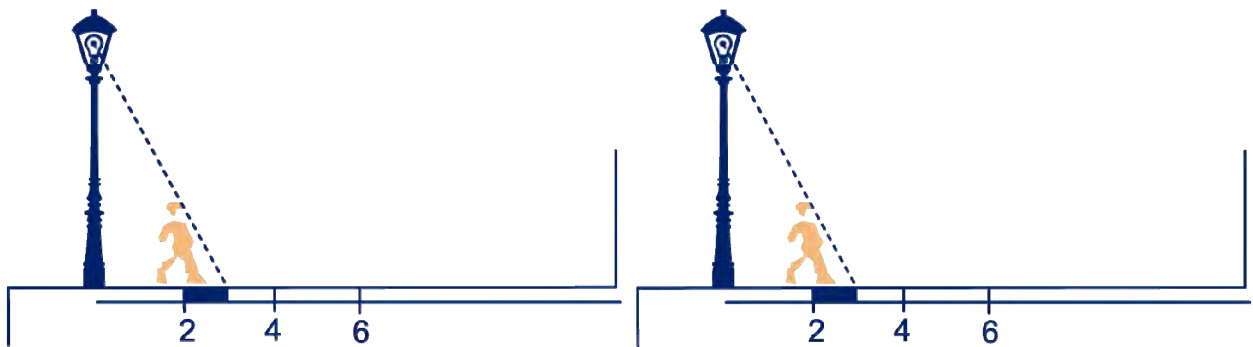

Opgave 29

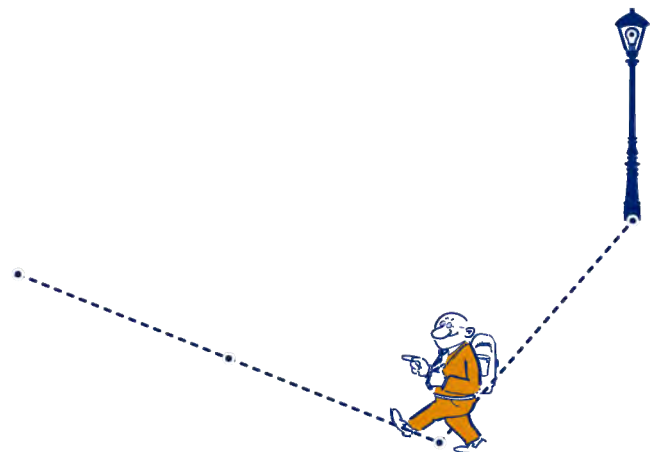

Opgave 30

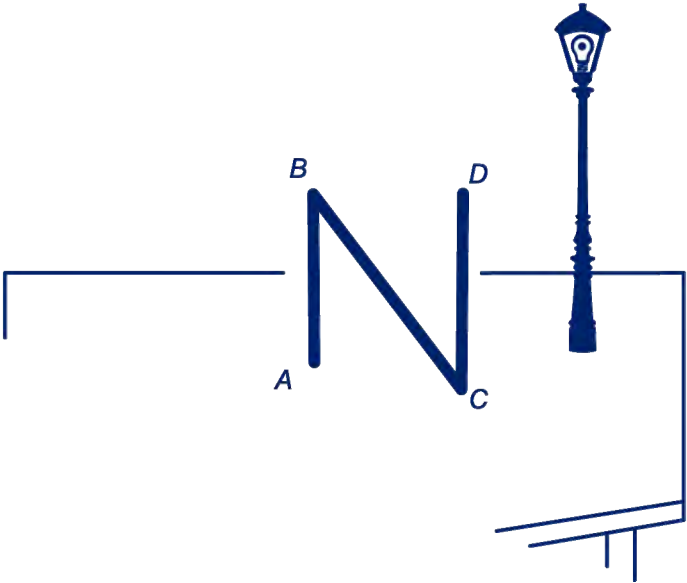

Opgave 31

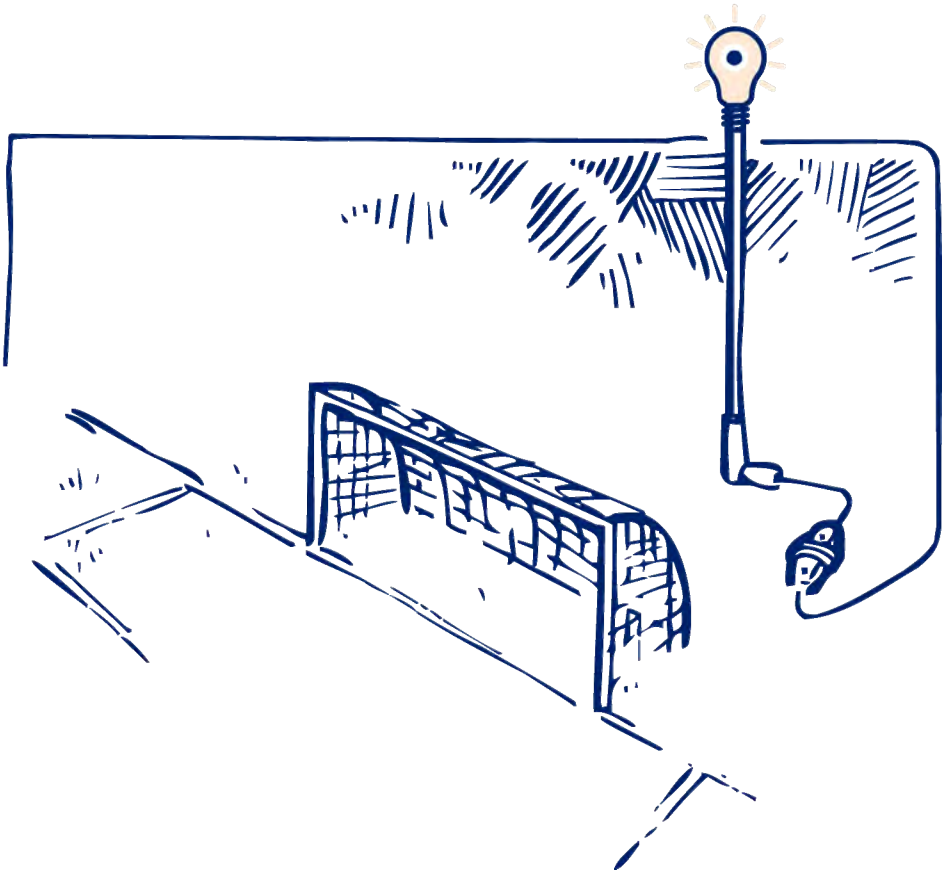

Opgave 32

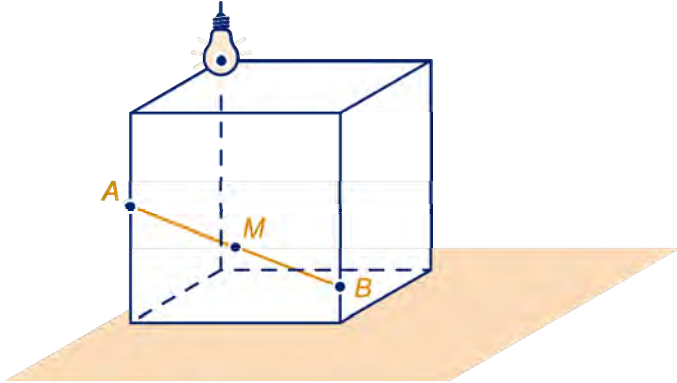

Opgave 33

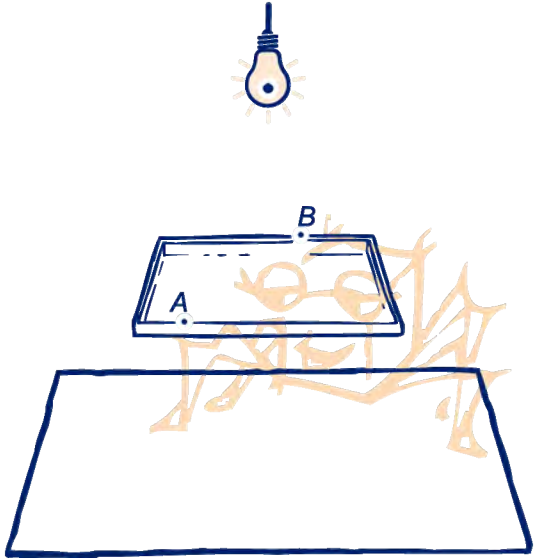

Opgave 34

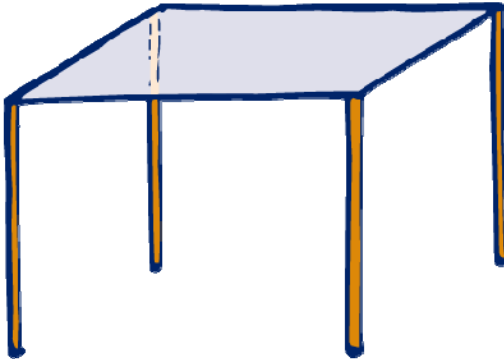

Opgave 35

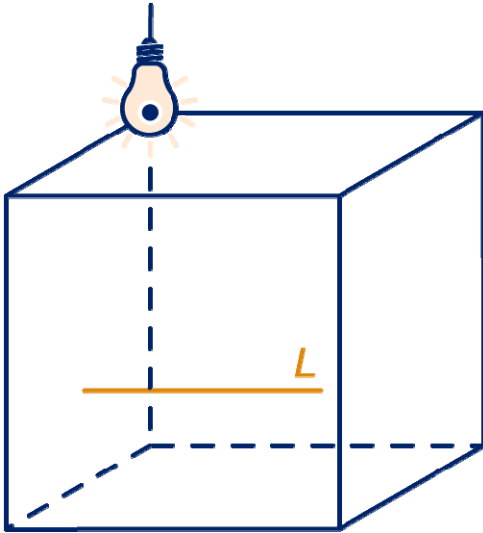

Opgave 36a

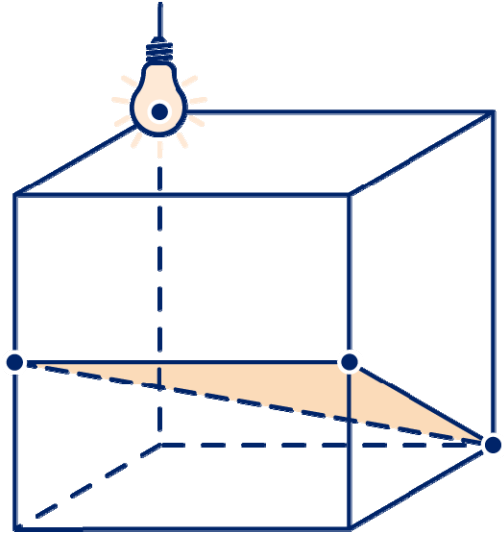

Opgave 36b

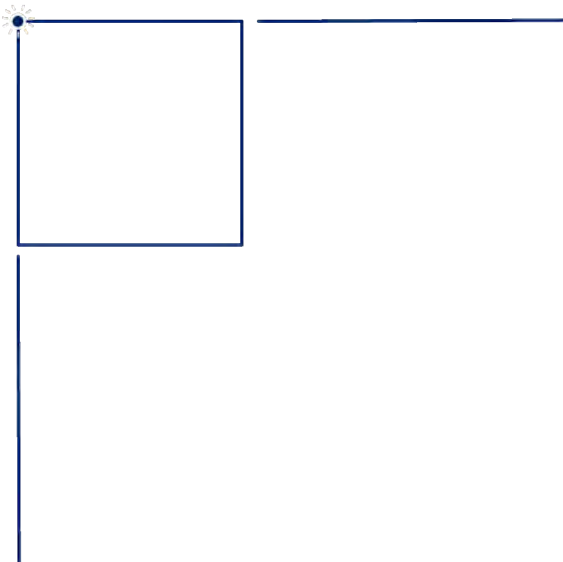

Opgave 37a



Opgave 37b



Opgave 41d

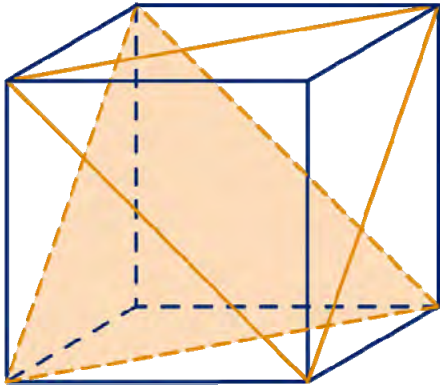

Opgave 44

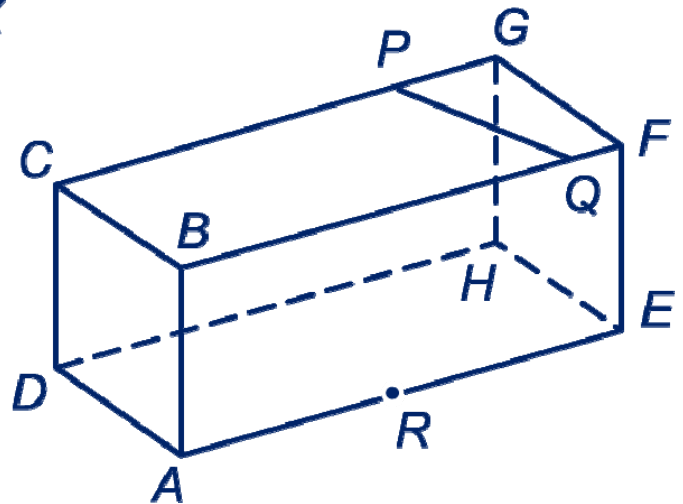
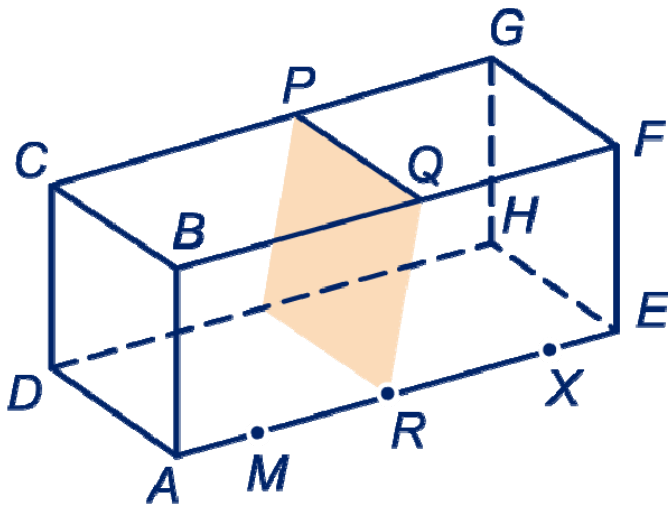

Opgave 45

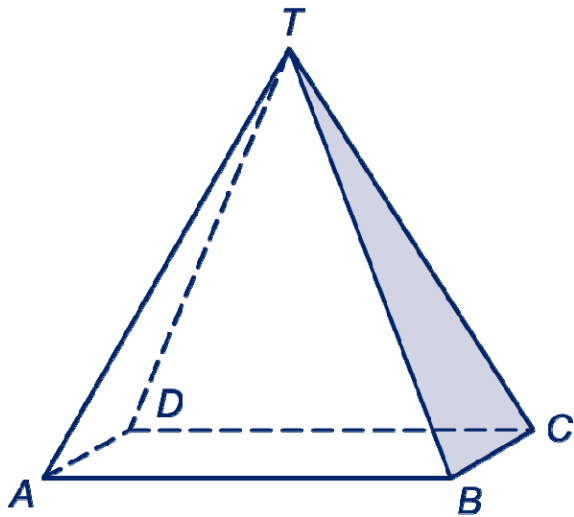

Super opgave 12

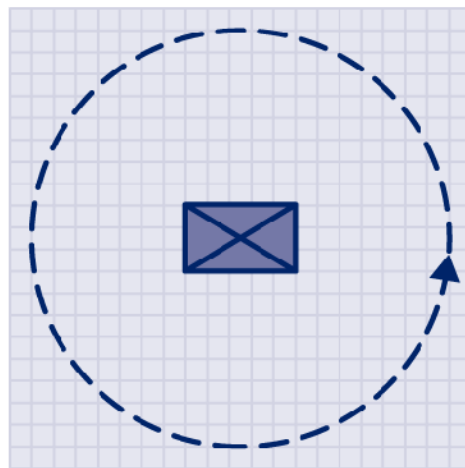
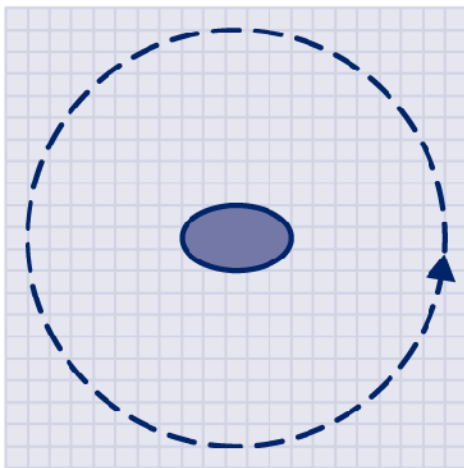

Extra opgave 5

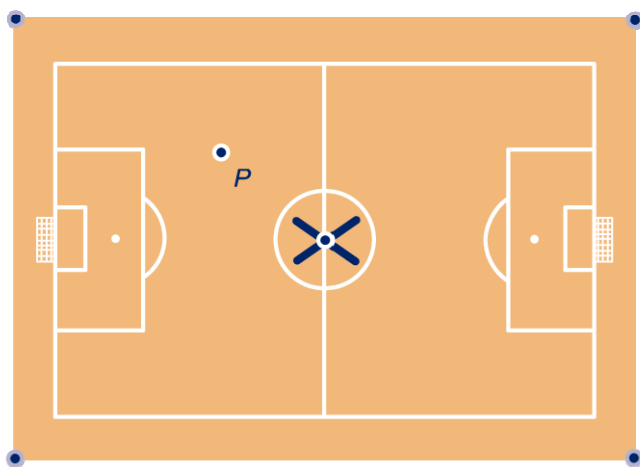

Extra opgave 6

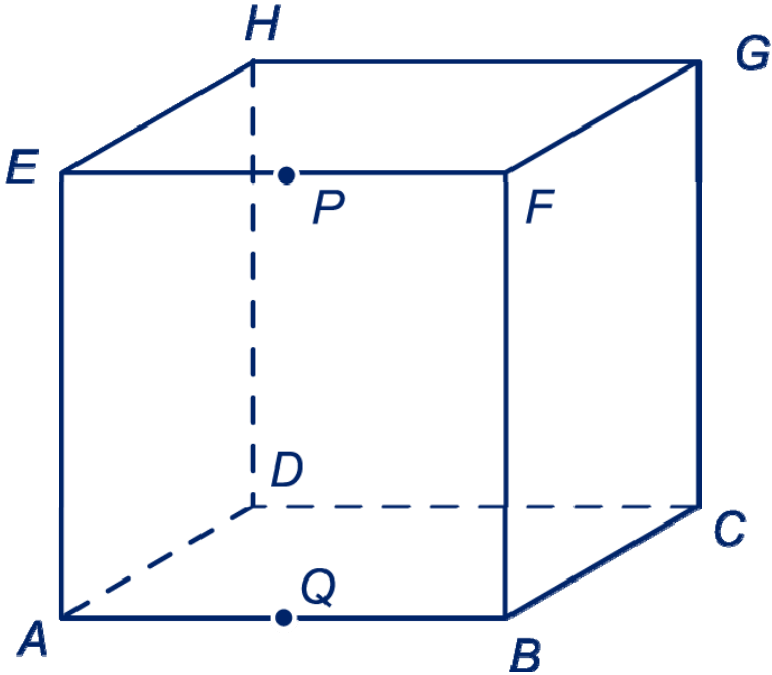

Extra opgave 11

